

R and R Blends

© 1993, Super Dupere School Co.

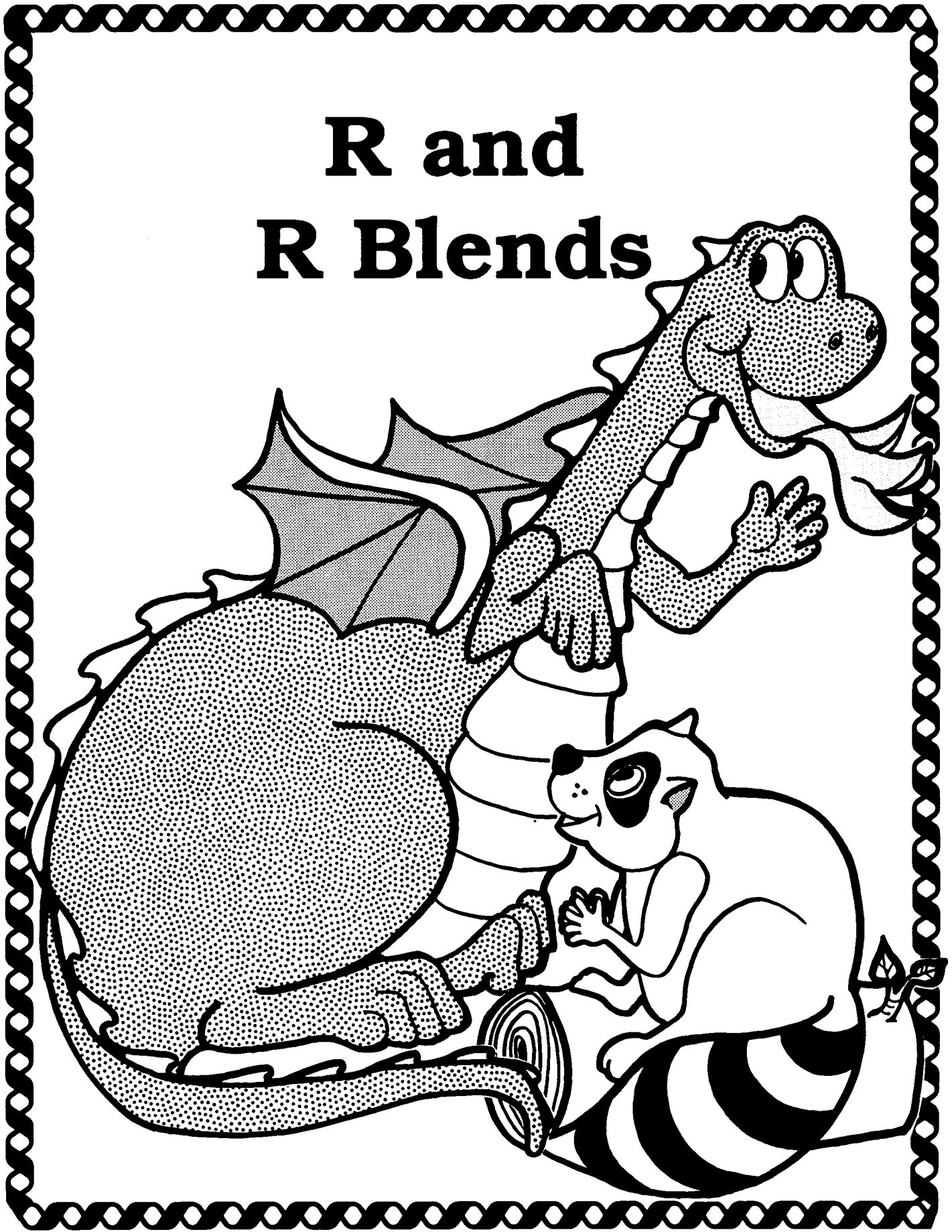

Initial R Words

Instructions _____

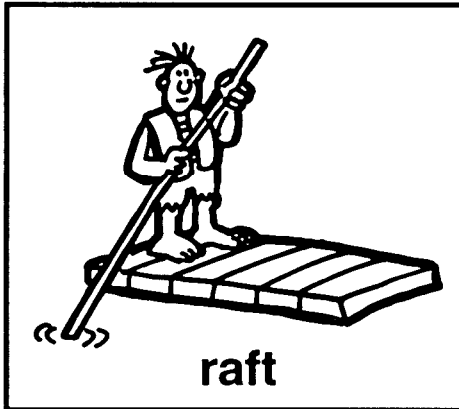

--	--	--	--	--	--	--	--	--	--	--	--

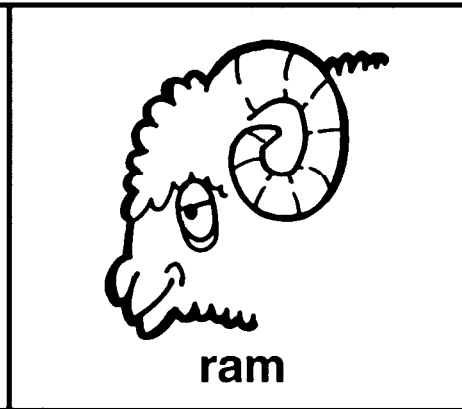

--	--	--	--	--	--	--	--	--	--	--	--



--	--	--	--	--	--	--	--	--	--	--	--



--	--	--	--	--	--	--	--	--	--	--	--

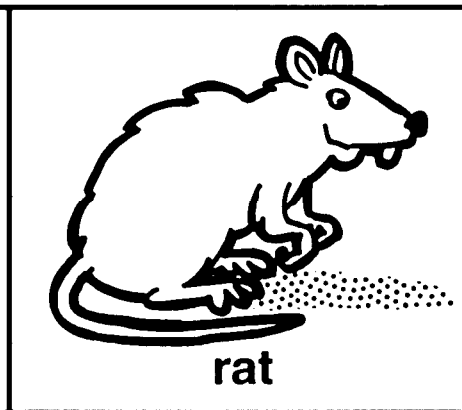

--	--	--	--	--	--	--	--	--	--	--	--

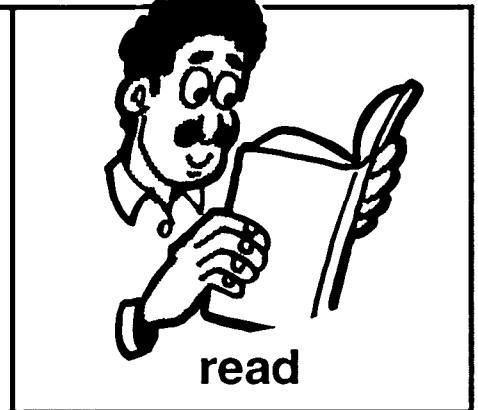

--	--	--	--	--	--	--	--	--	--	--	--

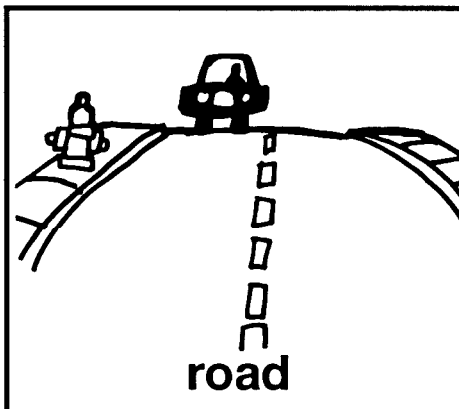

--	--	--	--	--	--	--	--	--	--	--	--

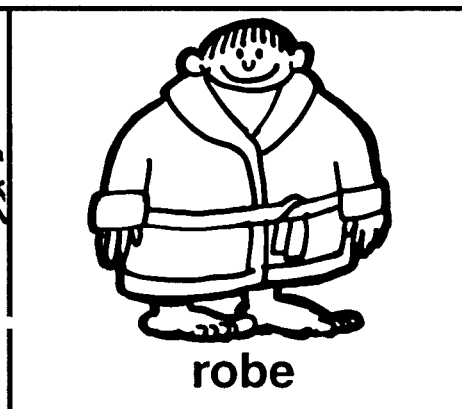

--	--	--	--	--	--	--	--	--	--	--	--

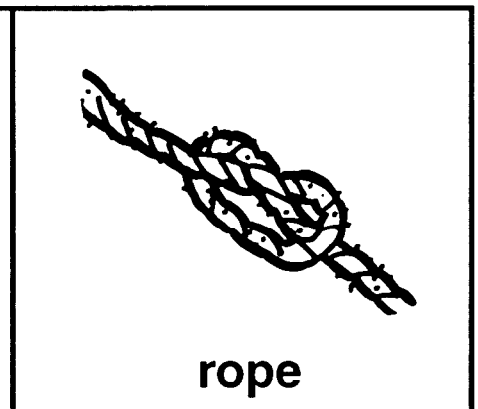

--	--	--	--	--	--	--	--	--	--	--	--

Name _____

Date _____



Helper's Signature _____

Speech-Language Pathologist _____

Skill: Initial R in words

Initial R Words

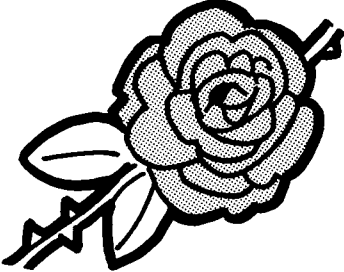
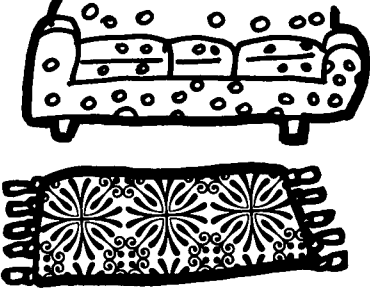

Instructions _____

 rose	 rug	 ring
--	---	--

--	--	--	--	--	--	--	--	--	--	--	--

--	--	--	--	--	--	--	--	--	--	--	--

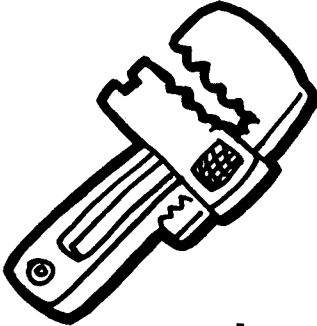
--	--	--	--	--	--	--	--	--	--	--	--

 wreath	 wrench	 roof
---	---	---

--	--	--	--	--	--	--	--	--	--	--	--

--	--	--	--	--	--	--	--	--	--	--	--

--	--	--	--	--	--	--	--	--	--	--	--

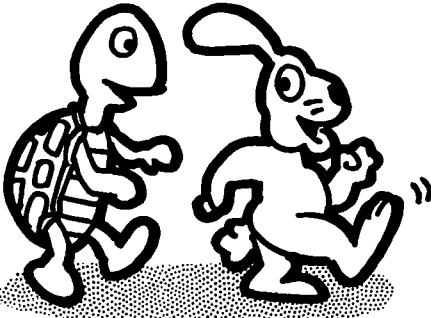
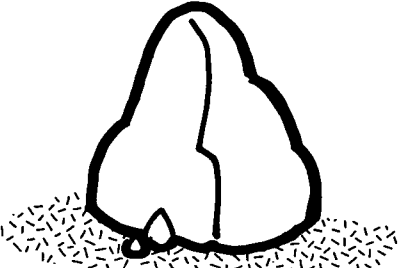
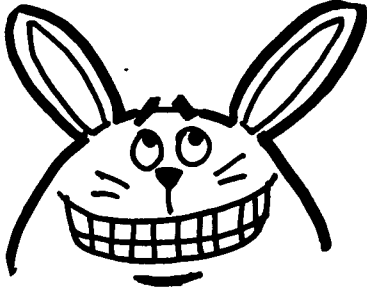
 race	 rock	 rabbit
--	--	--

--	--	--	--	--	--	--	--	--	--	--	--

--	--	--	--	--	--	--	--	--	--	--	--

--	--	--	--	--	--	--	--	--	--	--	--

Name _____ Date _____

Helper's Signature _____

Speech-Language Pathologist _____

Skill: Initial R in words

Initial R Words

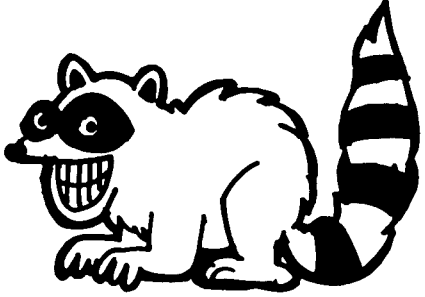
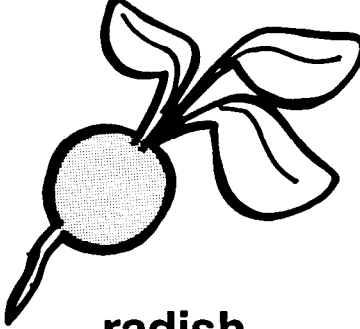
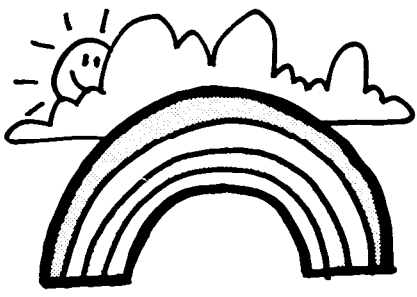

Instructions _____

 <p>raccoon</p>	 <p>radish</p>	 <p>rainbow</p>
---	--	---

--	--	--	--	--	--	--	--	--	--	--	--

--	--	--	--	--	--	--	--	--	--	--	--

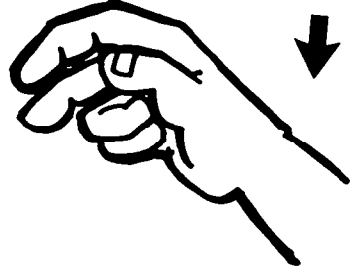

--	--	--	--	--	--	--	--	--	--	--	--

 <p>wrist</p>	 <p>rattle</p>	 <p>raincoat</p>
--	---	---

--	--	--	--	--	--	--	--	--	--	--	--

--	--	--	--	--	--	--	--	--	--	--	--

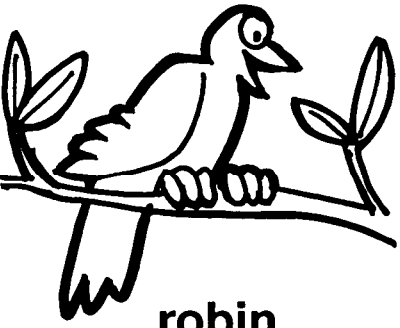
--	--	--	--	--	--	--	--	--	--	--	--

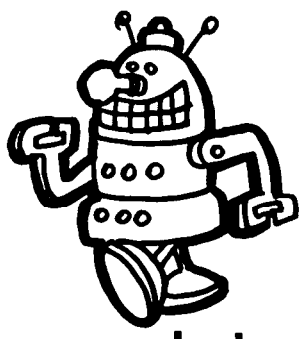
 <p>robin</p>	 <p>ribbon</p>	 <p>robot</p>
---	--	---

--	--	--	--	--	--	--	--	--	--	--	--

--	--	--	--	--	--	--	--	--	--	--	--

--	--	--	--	--	--	--	--	--	--	--	--

Name _____

Date _____

Helper's Signature _____

Speech-Language Pathologist _____

Skill: Initial R in words

Initial R Words

Instructions _____

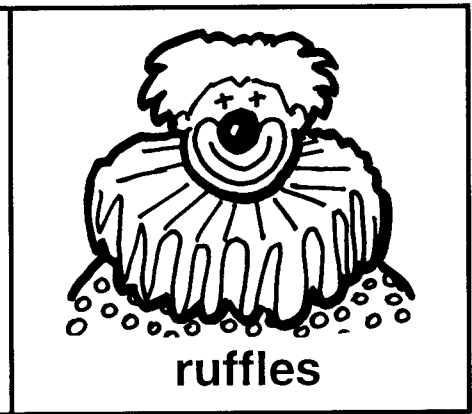
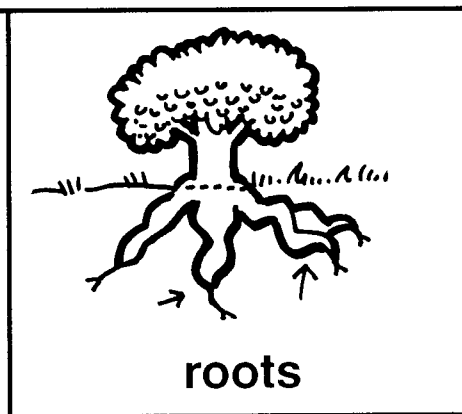
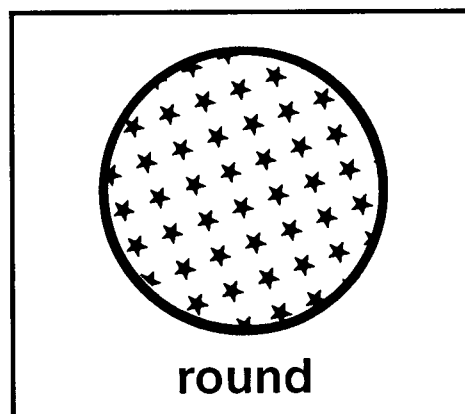
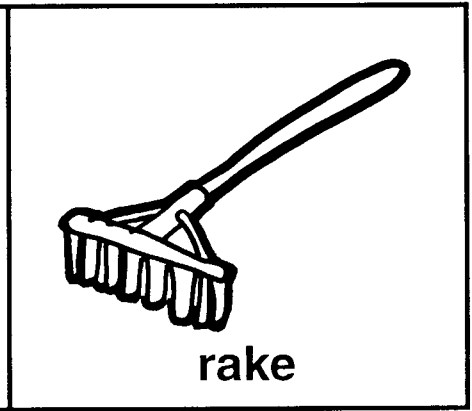
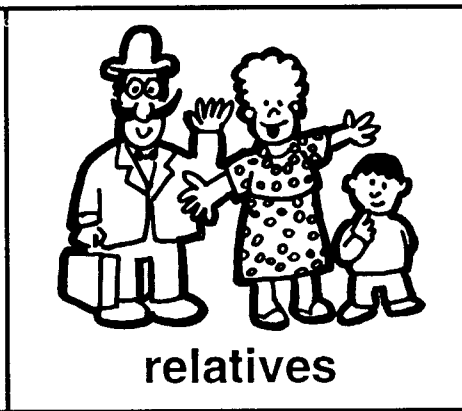
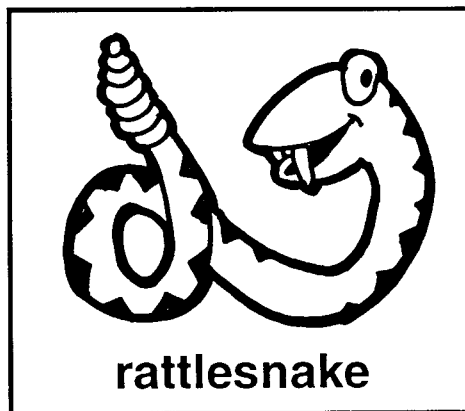
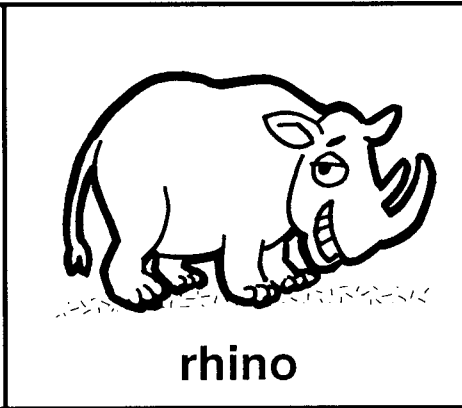
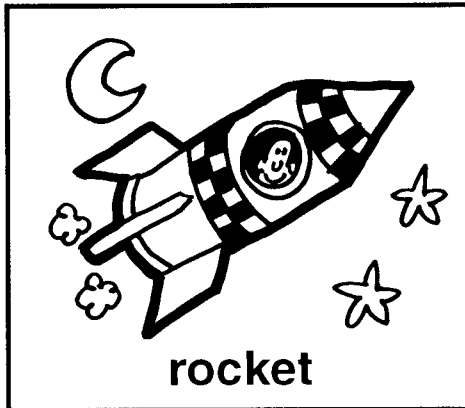

© 1993, Super Dupers School Co.

Name _____

Date _____



Helper's Signature _____

Speech-Language Pathologist _____

Skill: Initial R in words

Initial R Words

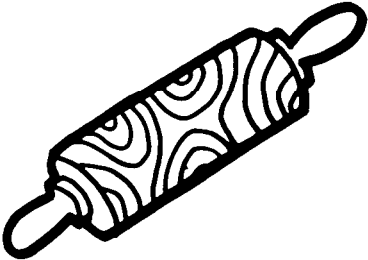
Instructions _____

 <p>rolling pin</p>	 <p>raisins</p>	 <p>rectangle</p>
---	---	---

--	--	--	--	--	--	--	--	--	--	--	--

--	--	--	--	--	--	--	--	--	--	--	--



--	--	--	--	--	--	--	--	--	--	--	--

 <p>rip</p>	 <p>reach</p>	 <p>rules</p>
--	--	--

--	--	--	--	--	--	--	--	--	--	--	--

--	--	--	--	--	--	--	--	--	--	--	--

--	--	--	--	--	--	--	--	--	--	--	--

 <p>roll</p>	 <p>resting</p>	 <p>rhumba</p>
--	---	--

--	--	--	--	--	--	--	--	--	--	--	--

--	--	--	--	--	--	--	--	--	--	--	--

--	--	--	--	--	--	--	--	--	--	--	--

Name _____

Date _____

Helper's Signature _____

Skill: Initial R in words

Speech-Language Pathologist _____

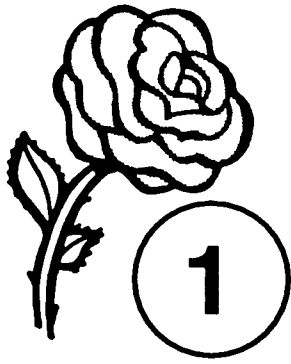

Initial R Words One Syllable

Instructions _____

© 1993, Super Dupers School Co.

- | | | | | | |
|-----------|----------------------|-----------|----------------------|------------|----------------------|
| 1. race | <input type="text"/> | 21. rhyme | <input type="text"/> | 41. root | <input type="text"/> |
| 2. raft | <input type="text"/> | 22. rib | <input type="text"/> | 42. rope | <input type="text"/> |
| 3. rag | <input type="text"/> | 23. rice | <input type="text"/> | 43. rose | <input type="text"/> |
| 4. raid | <input type="text"/> | 24. rich | <input type="text"/> | 44. round | <input type="text"/> |
| 5. rain | <input type="text"/> | 25. Rick | <input type="text"/> | 45. row | <input type="text"/> |
| 6. rake | <input type="text"/> | 26. ride | <input type="text"/> | 46. rub | <input type="text"/> |
| 7. ram | <input type="text"/> | 27. rig | <input type="text"/> | 47. rug | <input type="text"/> |
| 8. ran | <input type="text"/> | 28. right | <input type="text"/> | 48. rule | <input type="text"/> |
| 9. ranch | <input type="text"/> | 29. ring | <input type="text"/> | 49. run | <input type="text"/> |
| 10. rang | <input type="text"/> | 30. rinse | <input type="text"/> | 50. rung | <input type="text"/> |
| 11. range | <input type="text"/> | 31. rip | <input type="text"/> | 51. rush | <input type="text"/> |
| 12. rash | <input type="text"/> | 32. rise | <input type="text"/> | 52. rust | <input type="text"/> |
| 13. rat | <input type="text"/> | 33. roach | <input type="text"/> | 53. Ruth | <input type="text"/> |
| 14. rate | <input type="text"/> | 34. road | <input type="text"/> | 54. wrap | <input type="text"/> |
| 15. Ray | <input type="text"/> | 35. roast | <input type="text"/> | 55. wreath | <input type="text"/> |
| 16. reach | <input type="text"/> | 36. robe | <input type="text"/> | 56. wren | <input type="text"/> |
| 17. read | <input type="text"/> | 37. rock | <input type="text"/> | 57. wrench | <input type="text"/> |
| 18. red | <input type="text"/> | 38. roof | <input type="text"/> | 58. wrist | <input type="text"/> |
| 19. rent | <input type="text"/> | 39. room | <input type="text"/> | 59. write | <input type="text"/> |
| 20. rest | <input type="text"/> | 40. roost | <input type="text"/> | 60. wrong | <input type="text"/> |

Name _____

Date _____

Helper's Signature _____

Speech-Language Pathologist _____

Skill: Initial R in words, one syllable

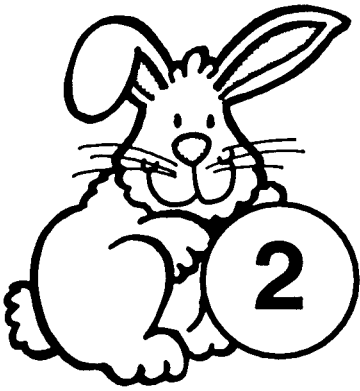

Initial R Words Two Syllables

Instructions _____

- | | | | | | |
|-------------|----------------------|-------------|----------------------|---------------|----------------------|
| 1. rabbit | <input type="text"/> | 21. recess | <input type="text"/> | 41. rocky | <input type="text"/> |
| 2. raccoon | <input type="text"/> | 22. reduce | <input type="text"/> | 42. Rodney | <input type="text"/> |
| 3. Rachel | <input type="text"/> | 23. refill | <input type="text"/> | 43. roofing | <input type="text"/> |
| 4. racing | <input type="text"/> | 24. refund | <input type="text"/> | 44. roomy | <input type="text"/> |
| 5. radish | <input type="text"/> | 25. relax | <input type="text"/> | 45. root beer | <input type="text"/> |
| 6. raffle | <input type="text"/> | 26. remove | <input type="text"/> | 46. rosebud | <input type="text"/> |
| 7. rainbow | <input type="text"/> | 27. repeat | <input type="text"/> | 47. rosy | <input type="text"/> |
| 8. raincoat | <input type="text"/> | 28. reply | <input type="text"/> | 48. rotten | <input type="text"/> |
| 9. rainfall | <input type="text"/> | 29. reptile | <input type="text"/> | 49. roundup | <input type="text"/> |
| 10. raisin | <input type="text"/> | 30. rescue | <input type="text"/> | 50. rowboat | <input type="text"/> |
| 11. ramble | <input type="text"/> | 31. respect | <input type="text"/> | 51. Ruby | <input type="text"/> |
| 12. Randy | <input type="text"/> | 32. result | <input type="text"/> | 52. ruffle | <input type="text"/> |
| 13. rattle | <input type="text"/> | 33. Rhonda | <input type="text"/> | 53. running | <input type="text"/> |
| 14. raven | <input type="text"/> | 34. ribbon | <input type="text"/> | 54. runway | <input type="text"/> |
| 15. Raymond | <input type="text"/> | 35. Ricky | <input type="text"/> | 55. Russell | <input type="text"/> |
| 16. reading | <input type="text"/> | 36. riddle | <input type="text"/> | 56. Russia | <input type="text"/> |
| 17. ready | <input type="text"/> | 37. rifle | <input type="text"/> | 57. rusty | <input type="text"/> |
| 18. reason | <input type="text"/> | 38. robin | <input type="text"/> | 58. wrapping | <input type="text"/> |
| 19. receipt | <input type="text"/> | 39. robot | <input type="text"/> | 59. wrestle | <input type="text"/> |
| 20. receive | <input type="text"/> | 40. rocket | <input type="text"/> | 60. wrinkle | <input type="text"/> |

© 1993, Super Dupree School Co.

Name _____ Date _____

Helper's Signature _____

Speech-Language Pathologist _____

Skill: Initial R in words, two syllables

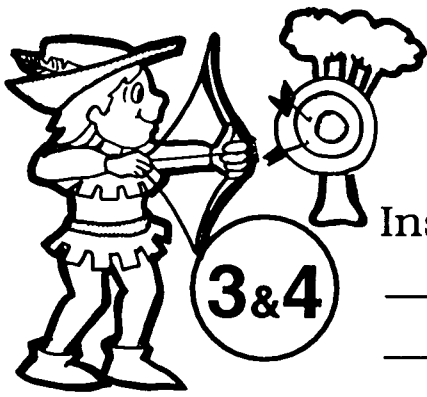

Initial R Words

Three and Four Syllables

Instructions _____

© 1993, Super Dupers School Co.

- | | | | | | |
|---------------|----------------------|------------------|----------------------|------------------|----------------------|
| 1. radiate | <input type="text"/> | 21. reconcile | <input type="text"/> | 41. road atlas | <input type="text"/> |
| 2. radial | <input type="text"/> | 22. rectangle | <input type="text"/> | 42. Robin Hood | <input type="text"/> |
| 3. radical | <input type="text"/> | 23. reduction | <input type="text"/> | 43. rodeo | <input type="text"/> |
| 4. radio | <input type="text"/> | 24. reflection | <input type="text"/> | 44. rolling pin | <input type="text"/> |
| 5. radium | <input type="text"/> | 25. regulate | <input type="text"/> | 45. romantic | <input type="text"/> |
| 6. ramshackle | <input type="text"/> | 26. related | <input type="text"/> | 46. Roxana | <input type="text"/> |
| 7. raspberry | <input type="text"/> | 27. relation | <input type="text"/> | 47. royalty | <input type="text"/> |
| 8. reaction | <input type="text"/> | 28. relatives | <input type="text"/> | 48. rummage sale | <input type="text"/> |
| 9. readjust | <input type="text"/> | 29. religion | <input type="text"/> | 49. runaway | <input type="text"/> |
| 10. realist | <input type="text"/> | 30. reluctant | <input type="text"/> | 50. wrongdoing | <input type="text"/> |
| 11. realize | <input type="text"/> | 31. remedy | <input type="text"/> | 51. reasonable | <input type="text"/> |
| 12. reappear | <input type="text"/> | 32. removal | <input type="text"/> | 52. reassemble | <input type="text"/> |
| 13. reasoning | <input type="text"/> | 33. resemblance | <input type="text"/> | 53. receptacle | <input type="text"/> |
| 14. Rebecca | <input type="text"/> | 34. resemble | <input type="text"/> | 54. recitation | <input type="text"/> |
| 15. reception | <input type="text"/> | 35. resentment | <input type="text"/> | 55. recognition | <input type="text"/> |
| 16. receptive | <input type="text"/> | 36. residence | <input type="text"/> | 56. recollection | <input type="text"/> |
| 17. recital | <input type="text"/> | 37. respectful | <input type="text"/> | 57. related | <input type="text"/> |
| 18. recognize | <input type="text"/> | 38. Rhode Island | <input type="text"/> | 58. removal | <input type="text"/> |
| 19. recollect | <input type="text"/> | 39. ridicule | <input type="text"/> | 59. rhinoceros | <input type="text"/> |
| 20. recommend | <input type="text"/> | 40. ritual | <input type="text"/> | 60. rutabaga | <input type="text"/> |

Name _____ Date _____

Speech-Language Pathologist _____

Helper's Signature _____

Skill: Initial R in words, three and four syllables

Initial R Phrases



Instructions _____

- 1. in the race
- 2. a rainy day
- 3. raking leaves
- 4. ran fast
- 5. a red rash
- 6. read a book
- 7. pay the rent
- 8. rinsing dishes
- 9. a rotten roof
- 10. give to Ruth
- 11. right or wrong
- 12. win the raffle
- 13. Ray and Ron
- 14. any reason
- 15. get ready now
- 16. shake a rattle
- 17. time to relax
- 18. the pink ribbon
- 19. baby robins
- 20. in the rocket

- 21. rocky road
- 22. rosy cheeks
- 23. a cold remedy
- 24. my refund
- 25. row the boat
- 26. in a rush
- 27. cooking roast
- 28. rich enough
- 29. a loud radio
- 30. resting easy
- 31. rip in pants
- 32. jumping rope
- 33. new rules
- 34. my white robe
- 35. out of reach
- 36. box of raisins
- 37. pack of rats
- 38. ramble along
- 39. eat a radish
- 40. a good reason

© 1993, Super Dupare School Co.

Name _____ Date _____

Helper's Signature _____

Speech-Language Pathologist _____

Skill: Initial R in phrases

Initial R Sentences



Instructions

© 1993, Super Dupers School Co.

- | | | | |
|---|----------------------|---|----------------------|
| 1. I will <u>r</u> un a <u>r</u> ace. | <input type="text"/> | 21. <u>R</u> ay <u>w</u> rapped the gift. | <input type="text"/> |
| 2. Is it <u>r</u> aining? | <input type="text"/> | 22. The <u>r</u> oof is leaky. | <input type="text"/> |
| 3. <u>R</u> ats like to eat cheese. | <input type="text"/> | 23. My blouse has <u>r</u> uffles. | <input type="text"/> |
| 4. Sit and <u>r</u> est awhile. | <input type="text"/> | 24. Please pass the <u>r</u> elish. | <input type="text"/> |
| 5. <u>R</u> on <u>r</u> eads books. | <input type="text"/> | 25. <u>R</u> abbits are good pets. | <input type="text"/> |
| 6. Can you <u>r</u> each the cookies? | <input type="text"/> | 26. His pants have a <u>r</u> ip. | <input type="text"/> |
| 7. This <u>r</u> oad is bumpy. | <input type="text"/> | 27. I <u>r</u> eally like <u>r</u> adishes. | <input type="text"/> |
| 8. Are you <u>r</u> eady to go? | <input type="text"/> | 28. Is this the <u>r</u> ight one? | <input type="text"/> |
| 9. The <u>r</u> ed <u>r</u> oses are lovely. | <input type="text"/> | 29. <u>R</u> ipe bananas taste good. | <input type="text"/> |
| 10. Did <u>R</u> ick see the <u>r</u> obin? | <input type="text"/> | 30. Mom got a pay <u>r</u> aise. | <input type="text"/> |
| 11. <u>R</u> uth will <u>r</u> ake the leaves. | <input type="text"/> | 31. <u>R</u> andy <u>r</u> uns fast. | <input type="text"/> |
| 12. The <u>r</u> usty <u>r</u> ocket is old. | <input type="text"/> | 32. The <u>r</u> adio is <u>r</u> eally loud! | <input type="text"/> |
| 13. Please eat the <u>r</u> aisins. | <input type="text"/> | 33. What a beautiful <u>r</u> ainbow! | <input type="text"/> |
| 14. <u>R</u> achel's <u>r</u> oom is messy. | <input type="text"/> | 34. A snake is a <u>r</u> eptile. | <input type="text"/> |
| 15. My <u>r</u> accoon <u>r</u> an away. | <input type="text"/> | 35. Please follow the <u>r</u> ules. | <input type="text"/> |
| 16. Is it time for <u>r</u> ecess? | <input type="text"/> | 36. Can you <u>r</u> ow the boat? | <input type="text"/> |
| 17. The <u>r</u> ent is due now. | <input type="text"/> | 37. It's time to <u>r</u> elax. | <input type="text"/> |
| 18. <u>R</u> oxy has a <u>r</u> uby <u>r</u> ing. | <input type="text"/> | 38. <u>R</u> oaches are yucky. | <input type="text"/> |
| 19. Do you like <u>r</u> oast beef? | <input type="text"/> | 39. Do you play <u>r</u> ugby? | <input type="text"/> |
| 20. Is that rash poison ivy? | <input type="text"/> | 40. You can <u>r</u> ely on me! | <input type="text"/> |

Name _____

Date _____

Speech-Language Pathologist _____

Helper's Signature _____

Skill: Initial R in sentences

Medial R Words

Instructions _____

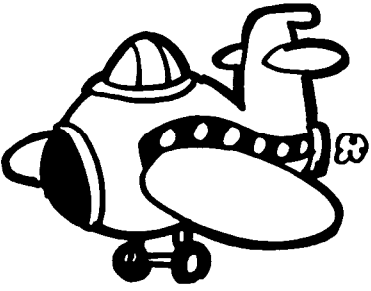
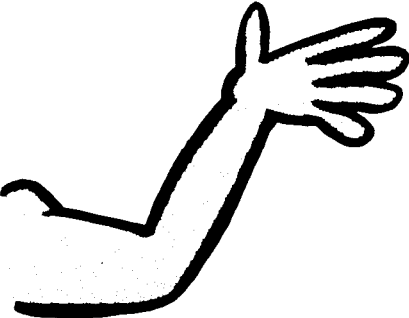
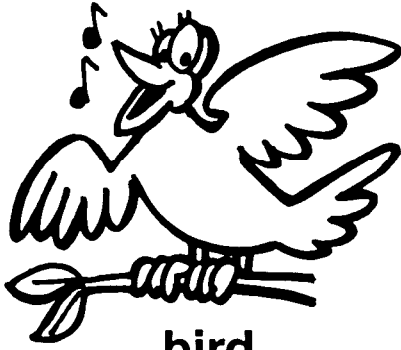
 <p>airplane</p>	 <p>arm</p>	 <p>bird</p>
---	---	---

--	--	--	--	--	--	--	--	--	--	--	--

--	--	--	--	--	--	--	--	--	--	--	--

--	--	--	--	--	--	--	--	--	--	--	--

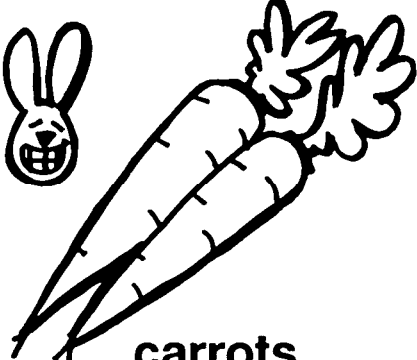
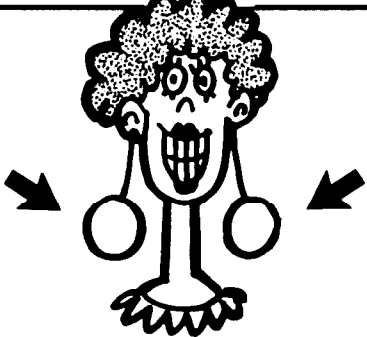
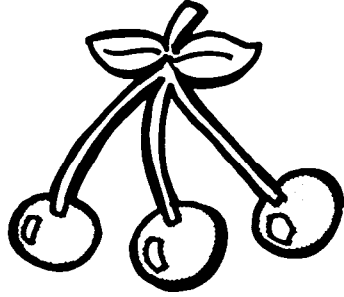
 <p>carrots</p>	 <p>earrings</p>	 <p>cherries</p>
---	--	--

--	--	--	--	--	--	--	--	--	--	--	--

--	--	--	--	--	--	--	--	--	--	--	--

--	--	--	--	--	--	--	--	--	--	--	--

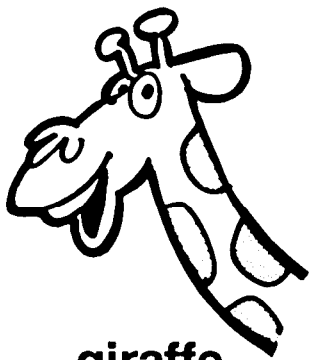
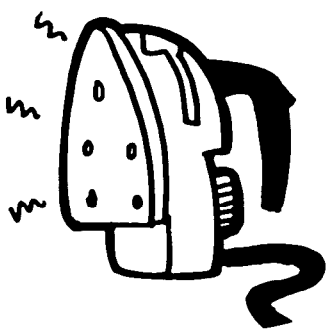
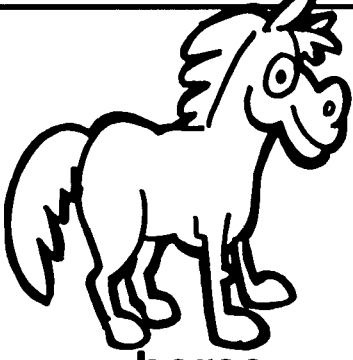
 <p>giraffe</p>	 <p>iron</p>	 <p>horse</p>
--	---	--

--	--	--	--	--	--	--	--	--	--	--	--

--	--	--	--	--	--	--	--	--	--	--	--

--	--	--	--	--	--	--	--	--	--	--	--

Name _____ Date _____

Helper's Signature _____

Speech-Language Pathologist _____

Skill: Medial R in words

Medial R Words

Instructions _____

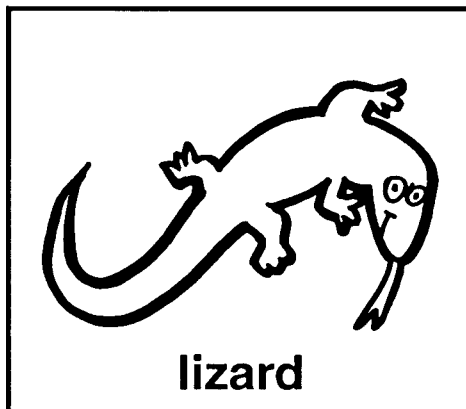

--	--	--	--	--	--	--	--	--	--	--	--

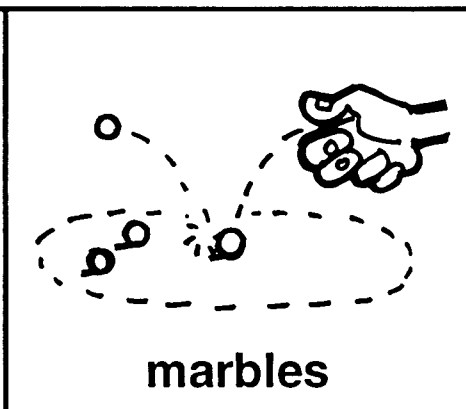

--	--	--	--	--	--	--	--	--	--	--	--

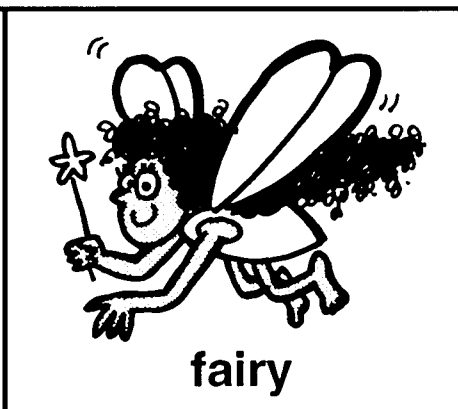

--	--	--	--	--	--	--	--	--	--	--	--

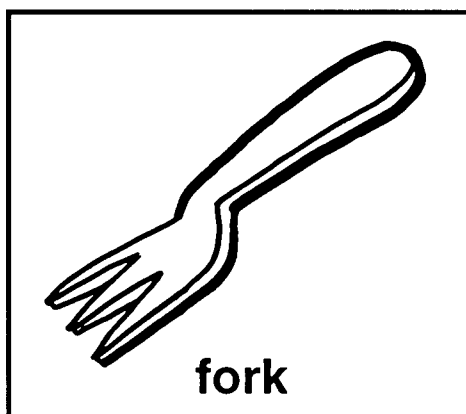

--	--	--	--	--	--	--	--	--	--	--	--

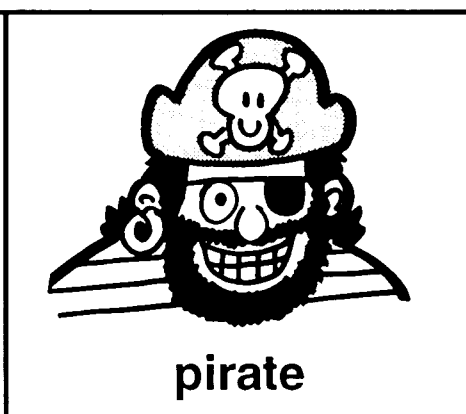

--	--	--	--	--	--	--	--	--	--	--	--

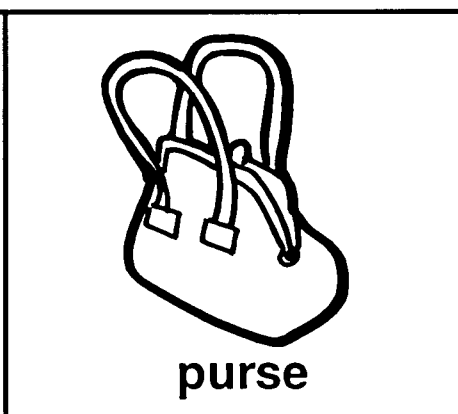

--	--	--	--	--	--	--	--	--	--	--	--

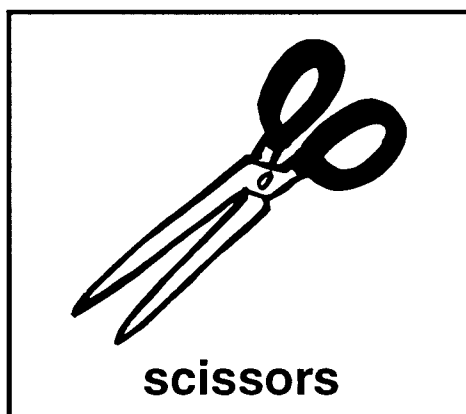

--	--	--	--	--	--	--	--	--	--	--	--



--	--	--	--	--	--	--	--	--	--	--	--



--	--	--	--	--	--	--	--	--	--	--	--

© 1993, Super Dupers School Co.

Name _____ Date _____

Speech-Language Pathologist _____

Helper's Signature _____

Skill: Medial R in words

Medial R Words

Instructions _____

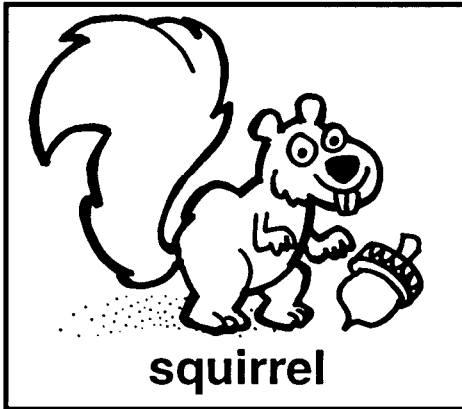

--	--	--	--	--	--	--	--	--	--	--	--

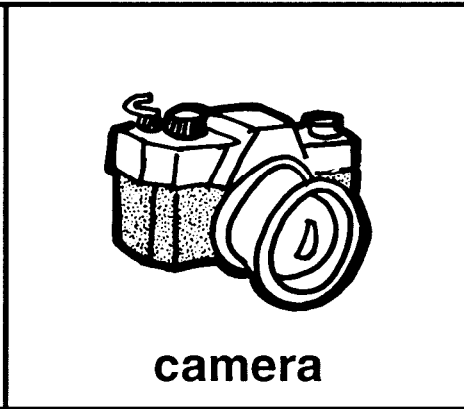

--	--	--	--	--	--	--	--	--	--	--	--

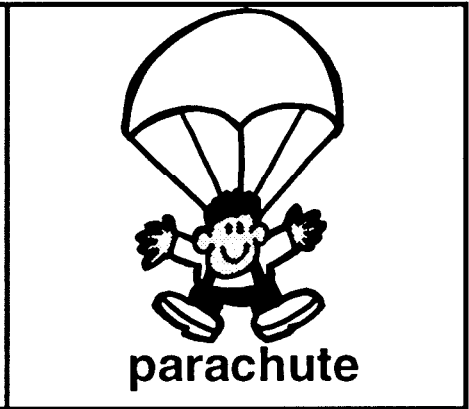

--	--	--	--	--	--	--	--	--	--	--	--



--	--	--	--	--	--	--	--	--	--	--	--

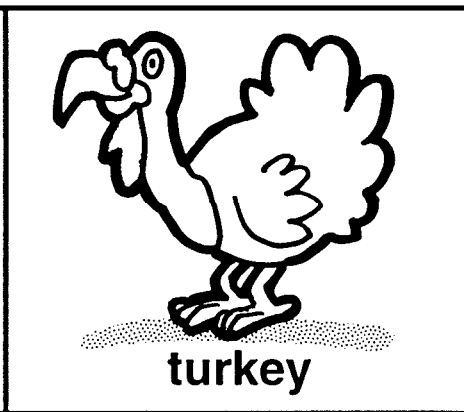

--	--	--	--	--	--	--	--	--	--	--	--

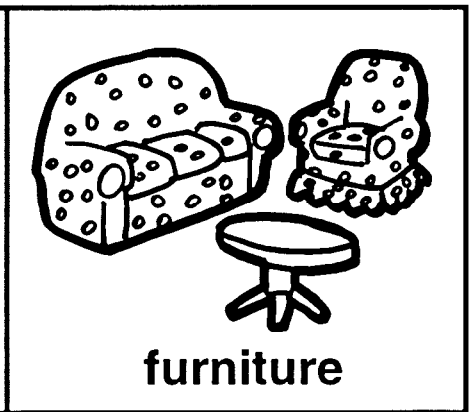

--	--	--	--	--	--	--	--	--	--	--	--

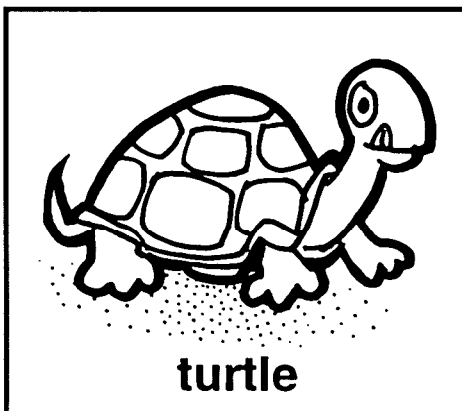

--	--	--	--	--	--	--	--	--	--	--	--

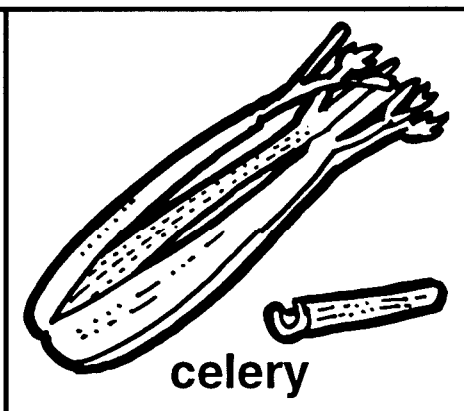

--	--	--	--	--	--	--	--	--	--	--	--

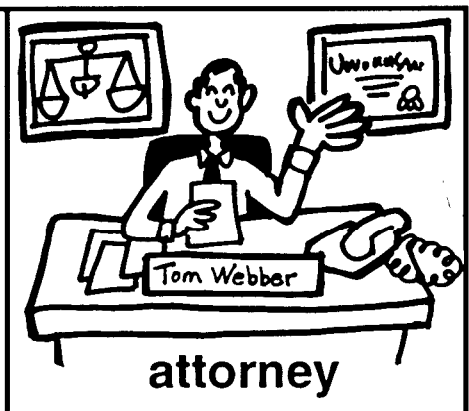

--	--	--	--	--	--	--	--	--	--	--	--

Name _____

Date _____

Helper's Signature _____

Skill: Medial R in words

Speech-Language Pathologist

Medial R Words

Instructions _____



--	--	--	--	--	--	--	--	--	--	--	--

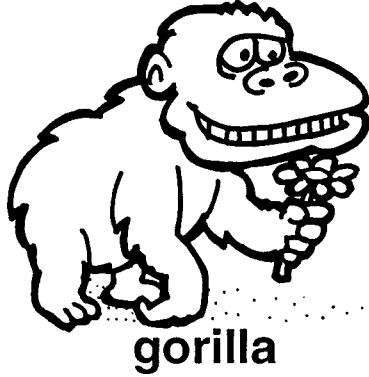

--	--	--	--	--	--	--	--	--	--	--	--

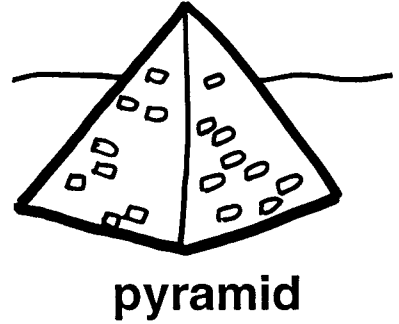

--	--	--	--	--	--	--	--	--	--	--	--

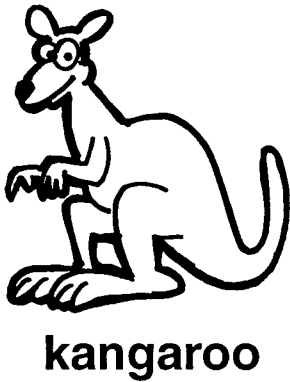

--	--	--	--	--	--	--	--	--	--	--	--

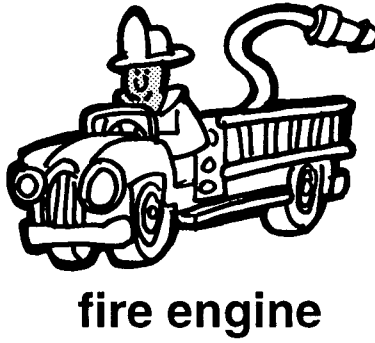

--	--	--	--	--	--	--	--	--	--	--	--

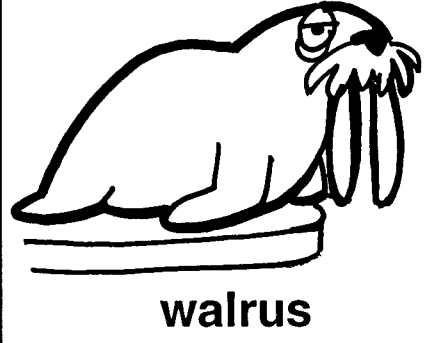

--	--	--	--	--	--	--	--	--	--	--	--



--	--	--	--	--	--	--	--	--	--	--	--

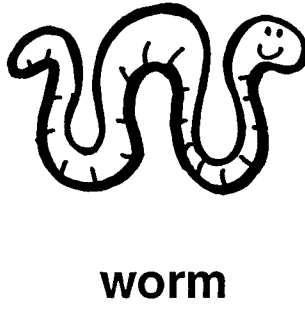

--	--	--	--	--	--	--	--	--	--	--	--



--	--	--	--	--	--	--	--	--	--	--	--

© 1993, Super Dupers School Co.

Name _____

Date _____



Helper's Signature _____

Skill: Medial R in words

Speech-Language Pathologist _____

Medial R Words

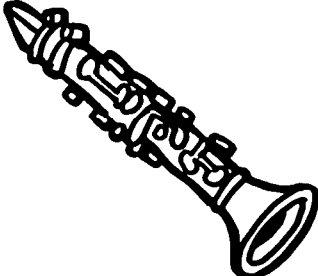
Instructions _____

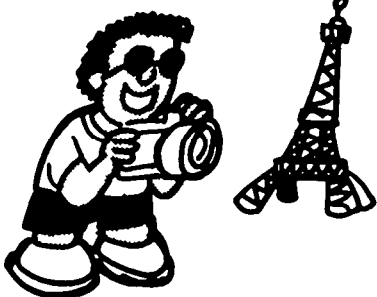
 <p>clarinet</p>	 <p>parasol</p>	 <p>tourist</p>
---	--	--

--	--	--	--	--	--	--	--	--	--	--	--

--	--	--	--	--	--	--	--	--	--	--	--



--	--	--	--	--	--	--	--	--	--	--	--

 <p>pearls</p>	 <p>park</p>	 <p>orange</p>
--	---	--

--	--	--	--	--	--	--	--	--	--	--	--

--	--	--	--	--	--	--	--	--	--	--	--

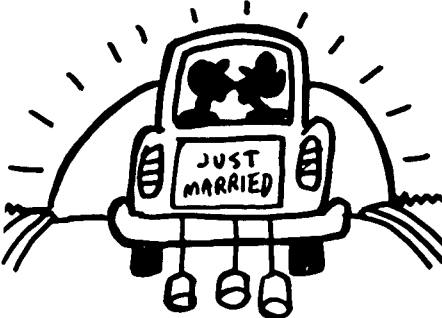
--	--	--	--	--	--	--	--	--	--	--	--

 <p>married</p>	 <p>syrup</p>	 <p>caribou</p>
--	--	--

--	--	--	--	--	--	--	--	--	--	--	--

--	--	--	--	--	--	--	--	--	--	--	--

--	--	--	--	--	--	--	--	--	--	--	--

Name _____ Date _____

Helper's Signature _____

Speech-Language Pathologist _____

Skill: Medial R in words

Medial R Words

Instructions _____

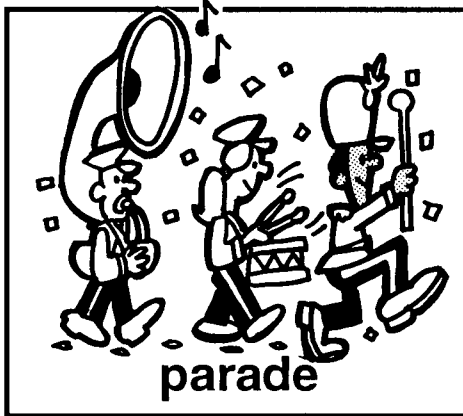

--	--	--	--	--	--	--	--	--	--	--	--

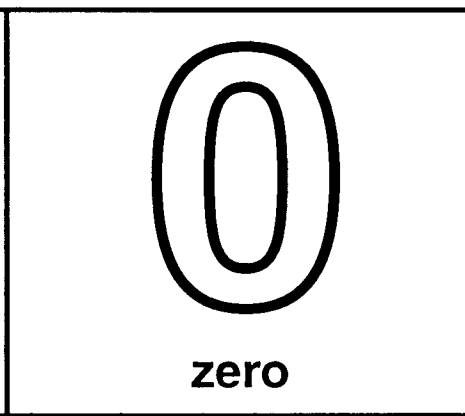

--	--	--	--	--	--	--	--	--	--	--	--



--	--	--	--	--	--	--	--	--	--	--	--

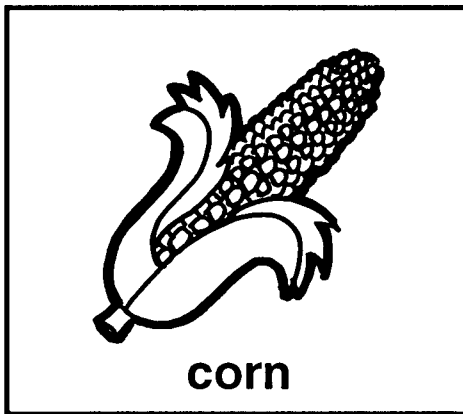

--	--	--	--	--	--	--	--	--	--	--	--

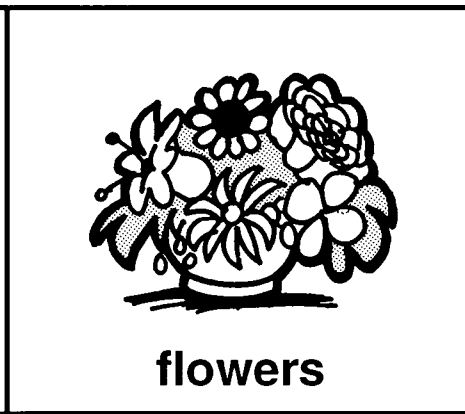

--	--	--	--	--	--	--	--	--	--	--	--

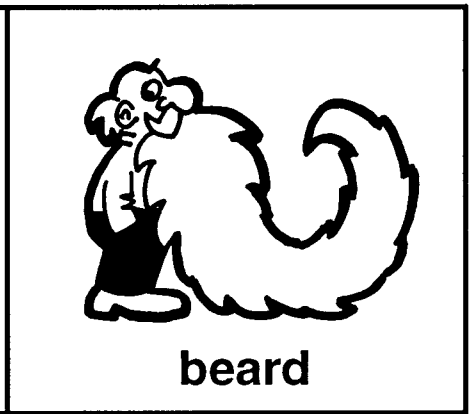

--	--	--	--	--	--	--	--	--	--	--	--

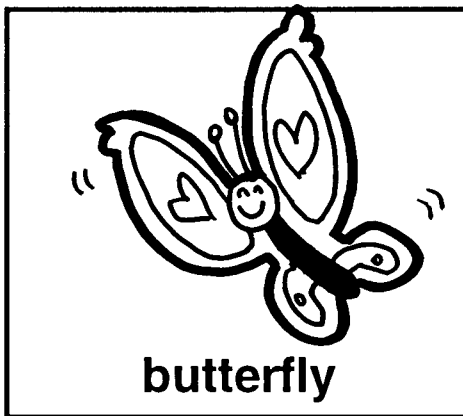

--	--	--	--	--	--	--	--	--	--	--	--

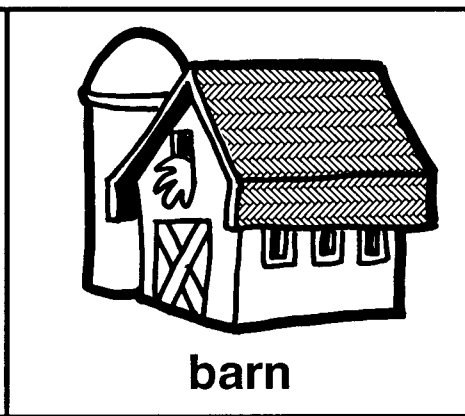

--	--	--	--	--	--	--	--	--	--	--	--

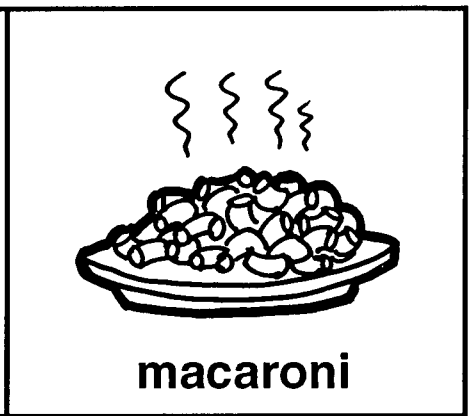

--	--	--	--	--	--	--	--	--	--	--	--

Name _____

Date _____

Helper's Signature _____

Speech-Language Pathologist _____

Skill: Medial R in words



Medial R Words

One and Two Syllables

Instructions _____

1&2

- | | | | | | |
|--------------|----------------------|--------------|----------------------|-------------|----------------------|
| 1. airplane | <input type="text"/> | 21. church | <input type="text"/> | 41. giraffe | <input type="text"/> |
| 2. arm | <input type="text"/> | 22. circle | <input type="text"/> | 42. girl | <input type="text"/> |
| 3. around | <input type="text"/> | 23. circus | <input type="text"/> | 43. guard | <input type="text"/> |
| 4. arrange | <input type="text"/> | 24. corn | <input type="text"/> | 44. Harry | <input type="text"/> |
| 5. arrest | <input type="text"/> | 25. curtains | <input type="text"/> | 45. hayride | <input type="text"/> |
| 6. arrive | <input type="text"/> | 26. dessert | <input type="text"/> | 46. hearing | <input type="text"/> |
| 7. arrow | <input type="text"/> | 27. dirty | <input type="text"/> | 47. heart | <input type="text"/> |
| 8. bargain | <input type="text"/> | 28. earring | <input type="text"/> | 48. herd | <input type="text"/> |
| 9. barking | <input type="text"/> | 29. fairy | <input type="text"/> | 49. hero | <input type="text"/> |
| 10. barn | <input type="text"/> | 30. farm | <input type="text"/> | 50. horse | <input type="text"/> |
| 11. barrel | <input type="text"/> | 31. first | <input type="text"/> | 51. hurry | <input type="text"/> |
| 12. beard | <input type="text"/> | 32. forest | <input type="text"/> | 52. iris | <input type="text"/> |
| 13. berries | <input type="text"/> | 33. fork | <input type="text"/> | 53. Irish | <input type="text"/> |
| 14. bird | <input type="text"/> | 34. forty | <input type="text"/> | 54. iron | <input type="text"/> |
| 15. burro | <input type="text"/> | 35. garage | <input type="text"/> | 55. Jerry | <input type="text"/> |
| 16. card | <input type="text"/> | 36. garbage | <input type="text"/> | 56. Karen | <input type="text"/> |
| 17. carpet | <input type="text"/> | 37. garden | <input type="text"/> | 57. Larry | <input type="text"/> |
| 18. carrots | <input type="text"/> | 38. garlic | <input type="text"/> | 58. lizard | <input type="text"/> |
| 19. cherries | <input type="text"/> | 39. Gary | <input type="text"/> | 59. marbles | <input type="text"/> |
| 20. chorus | <input type="text"/> | 40. Gerald | <input type="text"/> | 60. marine | <input type="text"/> |

© 1993, Super Dupree School Co.

Name _____ Date _____

Helper's Signature _____

Speech-Language Pathologist _____

Skill: Medial R in words, one and two syllables



Medial R Words

One and Two Syllables

Instructions _____

- | | | | | | |
|-------------|--|--------------|--|--------------|--|
| 1. maroon | <input type="checkbox"/> <input type="checkbox"/> <input type="checkbox"/> <input type="checkbox"/> <input type="checkbox"/> | 21. peril | <input type="checkbox"/> <input type="checkbox"/> <input type="checkbox"/> <input type="checkbox"/> <input type="checkbox"/> | 41. sorry | <input type="checkbox"/> <input type="checkbox"/> <input type="checkbox"/> <input type="checkbox"/> <input type="checkbox"/> |
| 2. married | <input type="checkbox"/> <input type="checkbox"/> <input type="checkbox"/> <input type="checkbox"/> <input type="checkbox"/> | 22. perish | <input type="checkbox"/> <input type="checkbox"/> <input type="checkbox"/> <input type="checkbox"/> <input type="checkbox"/> | 42. sparrow | <input type="checkbox"/> <input type="checkbox"/> <input type="checkbox"/> <input type="checkbox"/> <input type="checkbox"/> |
| 3. Mary | <input type="checkbox"/> <input type="checkbox"/> <input type="checkbox"/> <input type="checkbox"/> <input type="checkbox"/> | 23. Perry | <input type="checkbox"/> <input type="checkbox"/> <input type="checkbox"/> <input type="checkbox"/> <input type="checkbox"/> | 43. spirit | <input type="checkbox"/> <input type="checkbox"/> <input type="checkbox"/> <input type="checkbox"/> <input type="checkbox"/> |
| 4. merit | <input type="checkbox"/> <input type="checkbox"/> <input type="checkbox"/> <input type="checkbox"/> <input type="checkbox"/> | 24. Peru | <input type="checkbox"/> <input type="checkbox"/> <input type="checkbox"/> <input type="checkbox"/> <input type="checkbox"/> | 44. squirrel | <input type="checkbox"/> <input type="checkbox"/> <input type="checkbox"/> <input type="checkbox"/> <input type="checkbox"/> |
| 5. merry | <input type="checkbox"/> <input type="checkbox"/> <input type="checkbox"/> <input type="checkbox"/> <input type="checkbox"/> | 25. Pharaoh | <input type="checkbox"/> <input type="checkbox"/> <input type="checkbox"/> <input type="checkbox"/> <input type="checkbox"/> | 45. stary | <input type="checkbox"/> <input type="checkbox"/> <input type="checkbox"/> <input type="checkbox"/> <input type="checkbox"/> |
| 6. Morris | <input type="checkbox"/> <input type="checkbox"/> <input type="checkbox"/> <input type="checkbox"/> <input type="checkbox"/> | 26. pirate | <input type="checkbox"/> <input type="checkbox"/> <input type="checkbox"/> <input type="checkbox"/> <input type="checkbox"/> | 46. stirrup | <input type="checkbox"/> <input type="checkbox"/> <input type="checkbox"/> <input type="checkbox"/> <input type="checkbox"/> |
| 7. mural | <input type="checkbox"/> <input type="checkbox"/> <input type="checkbox"/> <input type="checkbox"/> <input type="checkbox"/> | 27. plural | <input type="checkbox"/> <input type="checkbox"/> <input type="checkbox"/> <input type="checkbox"/> <input type="checkbox"/> | 47. story | <input type="checkbox"/> <input type="checkbox"/> <input type="checkbox"/> <input type="checkbox"/> <input type="checkbox"/> |
| 8. narrow | <input type="checkbox"/> <input type="checkbox"/> <input type="checkbox"/> <input type="checkbox"/> <input type="checkbox"/> | 28. porridge | <input type="checkbox"/> <input type="checkbox"/> <input type="checkbox"/> <input type="checkbox"/> <input type="checkbox"/> | 48. sword | <input type="checkbox"/> <input type="checkbox"/> <input type="checkbox"/> <input type="checkbox"/> <input type="checkbox"/> |
| 9. nearly | <input type="checkbox"/> <input type="checkbox"/> <input type="checkbox"/> <input type="checkbox"/> <input type="checkbox"/> | 29. purse | <input type="checkbox"/> <input type="checkbox"/> <input type="checkbox"/> <input type="checkbox"/> <input type="checkbox"/> | 49. syrup | <input type="checkbox"/> <input type="checkbox"/> <input type="checkbox"/> <input type="checkbox"/> <input type="checkbox"/> |
| 10. nervous | <input type="checkbox"/> <input type="checkbox"/> <input type="checkbox"/> <input type="checkbox"/> <input type="checkbox"/> | 30. quarrel | <input type="checkbox"/> <input type="checkbox"/> <input type="checkbox"/> <input type="checkbox"/> <input type="checkbox"/> | 50. terrace | <input type="checkbox"/> <input type="checkbox"/> <input type="checkbox"/> <input type="checkbox"/> <input type="checkbox"/> |
| 11. nurse | <input type="checkbox"/> <input type="checkbox"/> <input type="checkbox"/> <input type="checkbox"/> <input type="checkbox"/> | 31. Sarah | <input type="checkbox"/> <input type="checkbox"/> <input type="checkbox"/> <input type="checkbox"/> <input type="checkbox"/> | 51. Terry | <input type="checkbox"/> <input type="checkbox"/> <input type="checkbox"/> <input type="checkbox"/> <input type="checkbox"/> |
| 12. oral | <input type="checkbox"/> <input type="checkbox"/> <input type="checkbox"/> <input type="checkbox"/> <input type="checkbox"/> | 32. scissors | <input type="checkbox"/> <input type="checkbox"/> <input type="checkbox"/> <input type="checkbox"/> <input type="checkbox"/> | 52. thorn | <input type="checkbox"/> <input type="checkbox"/> <input type="checkbox"/> <input type="checkbox"/> <input type="checkbox"/> |
| 13. orange | <input type="checkbox"/> <input type="checkbox"/> <input type="checkbox"/> <input type="checkbox"/> <input type="checkbox"/> | 33. serene | <input type="checkbox"/> <input type="checkbox"/> <input type="checkbox"/> <input type="checkbox"/> <input type="checkbox"/> | 53. tourist | <input type="checkbox"/> <input type="checkbox"/> <input type="checkbox"/> <input type="checkbox"/> <input type="checkbox"/> |
| 14. parade | <input type="checkbox"/> <input type="checkbox"/> <input type="checkbox"/> <input type="checkbox"/> <input type="checkbox"/> | 34. series | <input type="checkbox"/> <input type="checkbox"/> <input type="checkbox"/> <input type="checkbox"/> <input type="checkbox"/> | 54. turkey | <input type="checkbox"/> <input type="checkbox"/> <input type="checkbox"/> <input type="checkbox"/> <input type="checkbox"/> |
| 15. parent | <input type="checkbox"/> <input type="checkbox"/> <input type="checkbox"/> <input type="checkbox"/> <input type="checkbox"/> | 35. sharing | <input type="checkbox"/> <input type="checkbox"/> <input type="checkbox"/> <input type="checkbox"/> <input type="checkbox"/> | 55. turtle | <input type="checkbox"/> <input type="checkbox"/> <input type="checkbox"/> <input type="checkbox"/> <input type="checkbox"/> |
| 16. park | <input type="checkbox"/> <input type="checkbox"/> <input type="checkbox"/> <input type="checkbox"/> <input type="checkbox"/> | 36. Sharon | <input type="checkbox"/> <input type="checkbox"/> <input type="checkbox"/> <input type="checkbox"/> <input type="checkbox"/> | 56. Vera | <input type="checkbox"/> <input type="checkbox"/> <input type="checkbox"/> <input type="checkbox"/> <input type="checkbox"/> |
| 17. parrot | <input type="checkbox"/> <input type="checkbox"/> <input type="checkbox"/> <input type="checkbox"/> <input type="checkbox"/> | 37. sheriff | <input type="checkbox"/> <input type="checkbox"/> <input type="checkbox"/> <input type="checkbox"/> <input type="checkbox"/> | 57. walrus | <input type="checkbox"/> <input type="checkbox"/> <input type="checkbox"/> <input type="checkbox"/> <input type="checkbox"/> |
| 18. part | <input type="checkbox"/> <input type="checkbox"/> <input type="checkbox"/> <input type="checkbox"/> <input type="checkbox"/> | 38. Sherry | <input type="checkbox"/> <input type="checkbox"/> <input type="checkbox"/> <input type="checkbox"/> <input type="checkbox"/> | 58. worm | <input type="checkbox"/> <input type="checkbox"/> <input type="checkbox"/> <input type="checkbox"/> <input type="checkbox"/> |
| 19. party | <input type="checkbox"/> <input type="checkbox"/> <input type="checkbox"/> <input type="checkbox"/> <input type="checkbox"/> | 39. shirt | <input type="checkbox"/> <input type="checkbox"/> <input type="checkbox"/> <input type="checkbox"/> <input type="checkbox"/> | 59. zero | <input type="checkbox"/> <input type="checkbox"/> <input type="checkbox"/> <input type="checkbox"/> <input type="checkbox"/> |
| 20. pearls | <input type="checkbox"/> <input type="checkbox"/> <input type="checkbox"/> <input type="checkbox"/> <input type="checkbox"/> | 40. skirt | <input type="checkbox"/> <input type="checkbox"/> <input type="checkbox"/> <input type="checkbox"/> <input type="checkbox"/> | 60. Zorro | <input type="checkbox"/> <input type="checkbox"/> <input type="checkbox"/> <input type="checkbox"/> <input type="checkbox"/> |

© 1993, Super Dupere School Co.

Name _____ Date _____
Speech-Language Pathologist _____

Helper's Signature _____
Skill: Medial R in words, one and two syllables

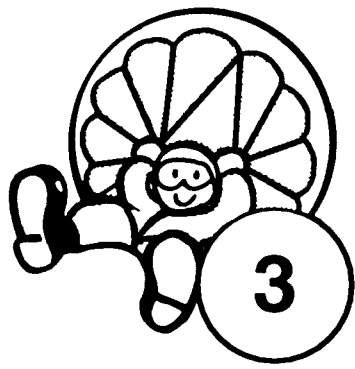

Medial R Words Three Syllables

Instructions _____

- | | | | | | |
|-----------------|----------------------|------------------|----------------------|-----------------|----------------------|
| 1. admiral | <input type="text"/> | 21. emerald | <input type="text"/> | 41. parachute | <input type="text"/> |
| 2. aerobics | <input type="text"/> | 22. everyone | <input type="text"/> | 42. paradise | <input type="text"/> |
| 3. apparel | <input type="text"/> | 23. exercise | <input type="text"/> | 43. parakeet | <input type="text"/> |
| 4. area | <input type="text"/> | 24. Ferris wheel | <input type="text"/> | 44. parasol | <input type="text"/> |
| 5. arrowhead | <input type="text"/> | 25. fire engine | <input type="text"/> | 45. peppermint | <input type="text"/> |
| 6. attorney | <input type="text"/> | 26. fishing rod | <input type="text"/> | 46. period | <input type="text"/> |
| 7. battery | <input type="text"/> | 27. furniture | <input type="text"/> | 47. pyramid | <input type="text"/> |
| 8. blueberries | <input type="text"/> | 28. gorilla | <input type="text"/> | 48. skyrocket | <input type="text"/> |
| 9. boomerang | <input type="text"/> | 29. hearing aid | <input type="text"/> | 49. tambourine | <input type="text"/> |
| 10. camera | <input type="text"/> | 30. horizon | <input type="text"/> | 50. teaberry | <input type="text"/> |
| 11. canary | <input type="text"/> | 31. hurricane | <input type="text"/> | 51. Teresa | <input type="text"/> |
| 12. caribou | <input type="text"/> | 32. injury | <input type="text"/> | 52. terrible | <input type="text"/> |
| 13. camation | <input type="text"/> | 33. insurance | <input type="text"/> | 53. terrific | <input type="text"/> |
| 14. casserole | <input type="text"/> | 34. kangaroo | <input type="text"/> | 54. therapist | <input type="text"/> |
| 15. celery | <input type="text"/> | 35. lariat | <input type="text"/> | 55. tomorrow | <input type="text"/> |
| 16. cherry pie | <input type="text"/> | 36. macaroon | <input type="text"/> | 56. various | <input type="text"/> |
| 17. clarinet | <input type="text"/> | 37. marigold | <input type="text"/> | 57. veranda | <input type="text"/> |
| 18. coral snake | <input type="text"/> | 38. Maryland | <input type="text"/> | 58. victory | <input type="text"/> |
| 19. diary | <input type="text"/> | 39. mulberry | <input type="text"/> | 59. wheelbarrow | <input type="text"/> |
| 20. Dorothy | <input type="text"/> | 40. Oregon | <input type="text"/> | 60. Zachary | <input type="text"/> |

© 1993, Super Dupres School Co.

Name _____ Date _____

Helper's Signature _____

Speech-Language Pathologist _____

Skill: Medial R in words, three syllables

Medial R Phrases

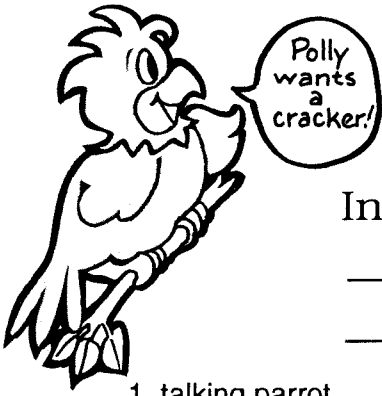

Instructions

1. talking parot
2. clean carpet
3. spoon and fork
4. to the circus
5. Jerry and Larry
6. ironing clothes
7. send a card
8. barrel of monkeys
9. bowl of berries
10. playing marbles
11. married to Karen
12. herd of cows
13. a little girl
14. make a circle
15. going to church
16. arms and legs
17. Gary's burro
18. love a parade
19. wearing pearls
20. apple and orange

21. hurry to work
22. very sorry
23. in my purse
24. Terry's parents
25. caring and sharing
26. Perry the pirate
27. shirt and skirt
28. in the park
29. eat a carrot
30. a nervous cat
31. the kind nurse
32. open parachute
33. his pet turtle
34. tell a story
35. starry night
36. in the garage
37. eat macaroni
38. happy gorilla
39. a long beard
40. forty lizards

© 1993, Super Dupere School Co.

Name

Date

Helper's Signature

Skill: Medial R in phrases

Speech-Language Pathologist

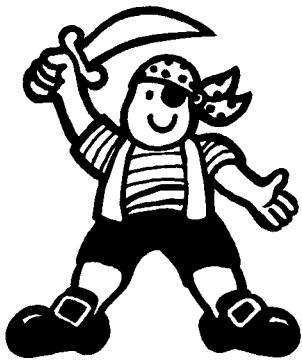

Medial R Sentences

Instructions _____

- | | | | |
|---------------------------------------|----------------------|--------------------------------------|----------------------|
| 1. Morris is a pirate. | <input type="text"/> | 21. Dorothy has new earrings. | <input type="text"/> |
| 2. Gary flew in the airplane. | <input type="text"/> | 22. We will exercise first. | <input type="text"/> |
| 3. He put his arm around her. | <input type="text"/> | 23. The forest is full of animals. | <input type="text"/> |
| 4. Barry found an arrowhead. | <input type="text"/> | 24. My bike is in the garage. | <input type="text"/> |
| 5. They will arrive tomorrow. | <input type="text"/> | 25. Did you see the gorilla? | <input type="text"/> |
| 6. The arrow hit the target. | <input type="text"/> | 26. Harry went on a hayride. | <input type="text"/> |
| 7. Terry is an attorney. | <input type="text"/> | 27. Teresa wears a hearing aid. | <input type="text"/> |
| 8. What a bargain! | <input type="text"/> | 28. A hurricane has strong winds. | <input type="text"/> |
| 9. Why is that dog barking? | <input type="text"/> | 29. Pat loves his Irish setter. | <input type="text"/> |
| 10. Your beard is soft. | <input type="text"/> | 30. Maryland is a state. | <input type="text"/> |
| 11. Can you pick berries with me? | <input type="text"/> | 31. Morris lives in Oregon. | <input type="text"/> |
| 12. She always takes a camera. | <input type="text"/> | 32. This is a narrow hallway. | <input type="text"/> |
| 13. A canary is a bird. | <input type="text"/> | 33. Dad took me to the parade. | <input type="text"/> |
| 14. I will send him a card. | <input type="text"/> | 34. Let's have a picnic in the park. | <input type="text"/> |
| 15. This casserole has carrots in it. | <input type="text"/> | 35. The pearls are in her purse. | <input type="text"/> |
| 16. Please pass the celery. | <input type="text"/> | 36. Teresa is sharing the candy. | <input type="text"/> |
| 17. We went to church yesterday. | <input type="text"/> | 37. Sherry wore a plaid skirt. | <input type="text"/> |
| 18. Dan is a circus clown. | <input type="text"/> | 38. I am sorry. | <input type="text"/> |
| 19. It's time to pick the corn. | <input type="text"/> | 39. What is your favorite story? | <input type="text"/> |
| 20. Did you write in your diary? | <input type="text"/> | 40. A turtle has a hard shell. | <input type="text"/> |

© 1993, Super Dupree School Co.

Name Date

Helper's Signature

Skill: Medial R in sentences

Final R Words

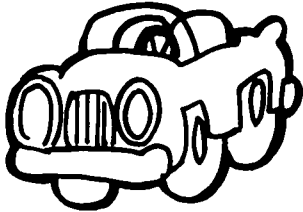
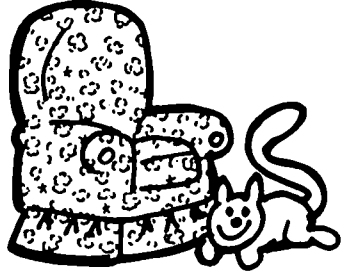

Instructions _____

 bear	 car	 chair
--	---	---

--	--	--	--	--	--	--	--	--	--

--	--	--	--	--	--	--	--	--	--

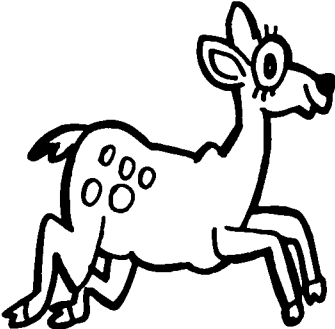
--	--	--	--	--	--	--	--	--	--

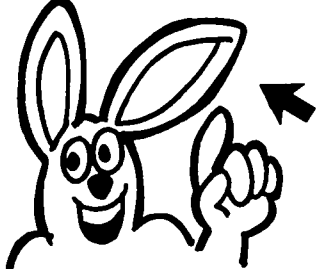
 deer	 door	 ear
---	---	--

--	--	--	--	--	--	--	--	--	--

--	--	--	--	--	--	--	--	--	--

--	--	--	--	--	--	--	--	--	--

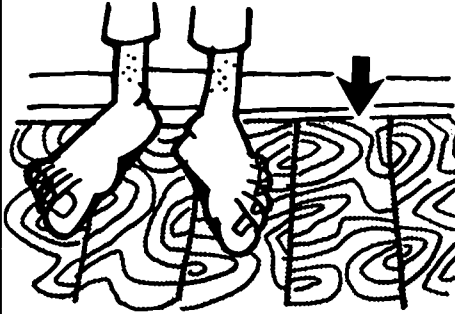
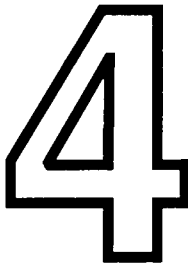
 fire	 floor	 four
--	--	--

--	--	--	--	--	--	--	--	--	--

--	--	--	--	--	--	--	--	--	--

--	--	--	--	--	--	--	--	--	--

© 1993, Super Dupers School Co.

Name _____ Date _____

Helper's Signature _____

Speech-Language Pathologist _____

Skill: Final R in words

Final R Words

Instructions _____



hair



jar

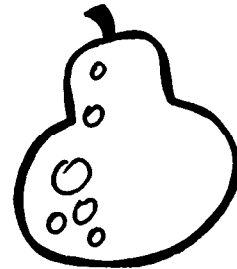

pear

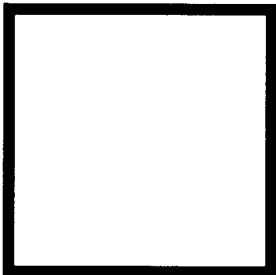

square

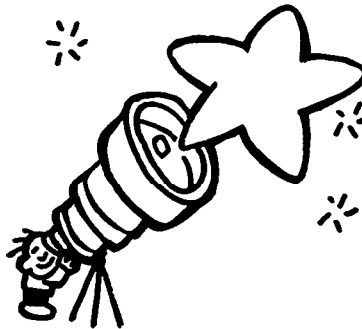

star

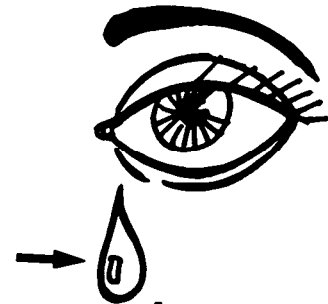

tear

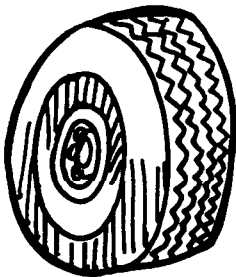

tire

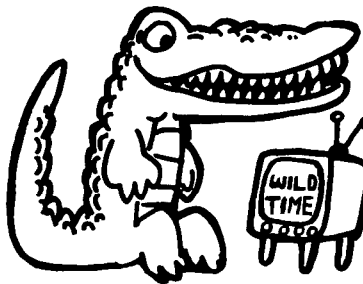

alligator

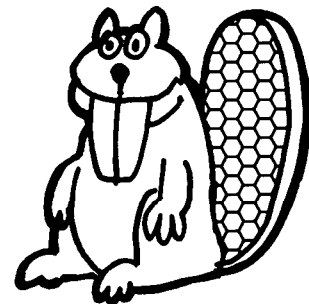

beaver

Name _____

Date _____

Helper's Signature _____



Skill: Final R in words

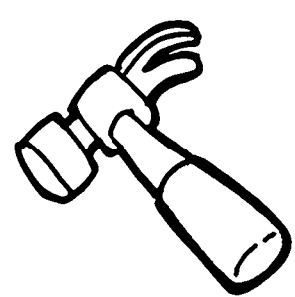
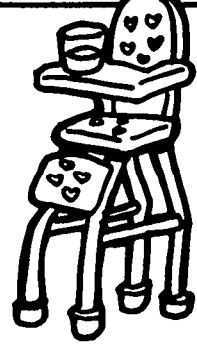

Speech-Language Pathologist _____

Final R Words

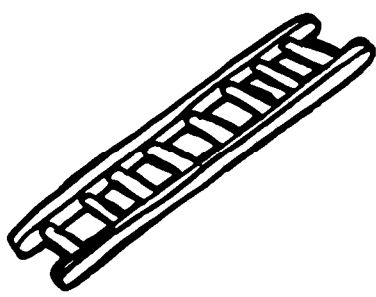
Instructions _____

 <p>guitar</p>	 <p>hammer</p>	 <p>highchair</p>
--	--	---

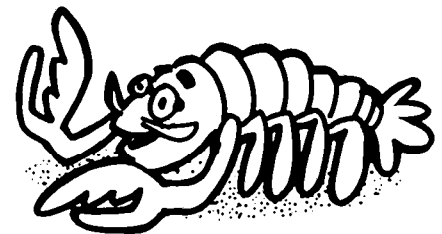
 <p>juggler</p>	 <p>ladder</p>	 <p>letter</p>
--	--	---

 <p>lobster</p>	 <p>matador</p>	 <p>mother</p>
---	--	--

Name _____

Date _____

Helper's Signature _____

Skill: Final R in words

Speech-Language Pathologist _____

Final R Words

Instructions _____



newspaper



painter

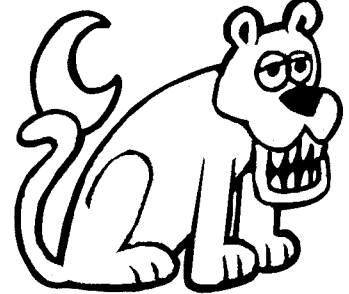

panther



sailor

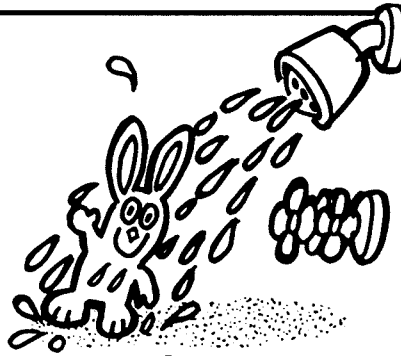

shower

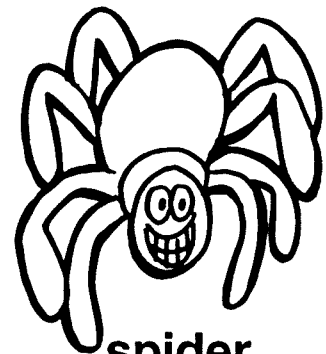

spider



sugar

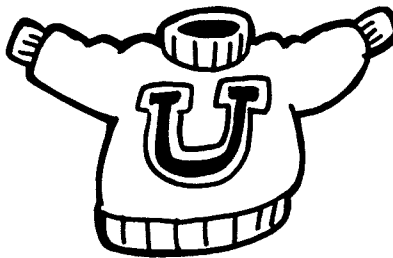

sweater



teacher

© 1993, Super Dupers School Co.

Name _____

Date _____



Helper's Signature _____



Skill: Final R in words

Speech-Language Pathologist _____

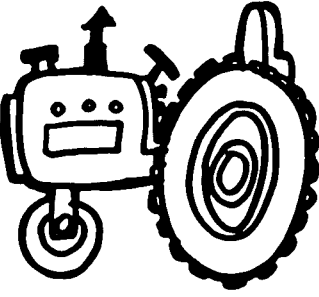
Final R Words

Instructions _____

 <p>tiger</p>	 <p>tractor</p>	 <p>umpire</p>
--	--	---

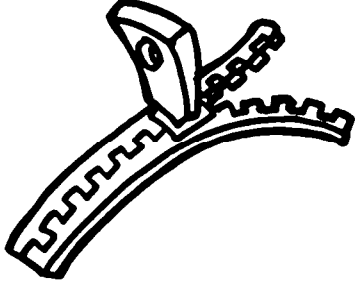
 <p>vampire</p>	 <p>wheelchair</p>	 <p>zipper</p>
---	---	--

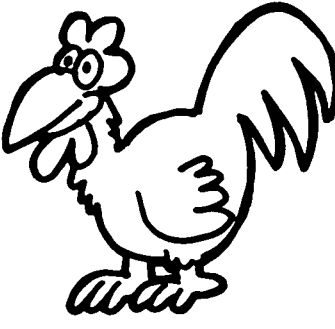
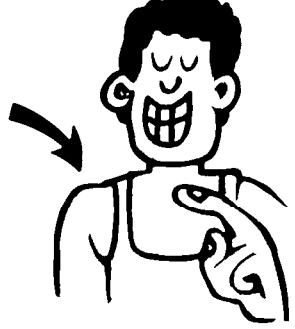
 <p>plumber</p>	 <p>rooster</p>	 <p>shoulder</p>
--	--	---

Name _____

Date _____

Helper's Signature _____

Skill: Final R in words

Speech-Language Pathologist _____

Final R Words One Syllable



Instructions _____

© 1993, Super Dupers School Co.

- | | | | | | |
|-----------|----------------------|-----------|----------------------|------------|----------------------|
| 1. air | <input type="text"/> | 21. four | <input type="text"/> | 41. shore | <input type="text"/> |
| 2. are | <input type="text"/> | 22. fur | <input type="text"/> | 42. sir | <input type="text"/> |
| 3. bare | <input type="text"/> | 23. gear | <input type="text"/> | 43. smear | <input type="text"/> |
| 4. bear | <input type="text"/> | 24. hair | <input type="text"/> | 44. sore | <input type="text"/> |
| 5. blur | <input type="text"/> | 25. here | <input type="text"/> | 45. sour | <input type="text"/> |
| 6. boar | <input type="text"/> | 26. her | <input type="text"/> | 46. spare | <input type="text"/> |
| 7. car | <input type="text"/> | 27. hour | <input type="text"/> | 47. spear | <input type="text"/> |
| 8. care | <input type="text"/> | 28. jar | <input type="text"/> | 48. square | <input type="text"/> |
| 9. chair | <input type="text"/> | 29. mare | <input type="text"/> | 49. stair | <input type="text"/> |
| 10. cheer | <input type="text"/> | 30. more | <input type="text"/> | 50. star | <input type="text"/> |
| 11. chore | <input type="text"/> | 31. near | <input type="text"/> | 51. stare | <input type="text"/> |
| 12. clear | <input type="text"/> | 32. oar | <input type="text"/> | 52. stir | <input type="text"/> |
| 13. deer | <input type="text"/> | 33. pair | <input type="text"/> | 53. sure | <input type="text"/> |
| 14. door | <input type="text"/> | 34. pear | <input type="text"/> | 54. tear | <input type="text"/> |
| 15. ear | <input type="text"/> | 35. pier | <input type="text"/> | 55. tire | <input type="text"/> |
| 16. fair | <input type="text"/> | 36. pour | <input type="text"/> | 56. tore | <input type="text"/> |
| 17. fear | <input type="text"/> | 37. purr | <input type="text"/> | 57. wear | <input type="text"/> |
| 18. fir | <input type="text"/> | 38. score | <input type="text"/> | 58. wire | <input type="text"/> |
| 19. fire | <input type="text"/> | 39. share | <input type="text"/> | 59. year | <input type="text"/> |
| 20. floor | <input type="text"/> | 40. shear | <input type="text"/> | 60. your | <input type="text"/> |

Name _____

Date _____

Helper's Signature _____

Speech-Language Pathologist _____

Skill: Final R in words, one syllable

Final R Words

Two or More Syllables

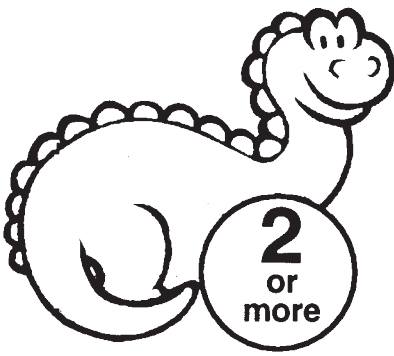

Instructions _____

- | | | | | | |
|---------------|----------------------|---------------|----------------------|----------------|----------------------|
| 1. admire | <input type="text"/> | 21. father | <input type="text"/> | 41. pepper | <input type="text"/> |
| 2. afar | <input type="text"/> | 22. feather | <input type="text"/> | 42. plumber | <input type="text"/> |
| 3. alligator | <input type="text"/> | 23. finger | <input type="text"/> | 43. razor | <input type="text"/> |
| 4. ashore | <input type="text"/> | 24. flower | <input type="text"/> | 44. robber | <input type="text"/> |
| 5. baker | <input type="text"/> | 25. gopher | <input type="text"/> | 45. rooster | <input type="text"/> |
| 6. beaver | <input type="text"/> | 26. guitar | <input type="text"/> | 46. sailor | <input type="text"/> |
| 7. bookstore | <input type="text"/> | 27. hammer | <input type="text"/> | 47. shoulder | <input type="text"/> |
| 8. boxcar | <input type="text"/> | 28. highchair | <input type="text"/> | 48. shower | <input type="text"/> |
| 9. brother | <input type="text"/> | 29. jaguar | <input type="text"/> | 49. sister | <input type="text"/> |
| 10. campfire | <input type="text"/> | 30. juggler | <input type="text"/> | 50. spider | <input type="text"/> |
| 11. cashier | <input type="text"/> | 31. ladder | <input type="text"/> | 51. sugar | <input type="text"/> |
| 12. collar | <input type="text"/> | 32. letter | <input type="text"/> | 52. sweater | <input type="text"/> |
| 13. dinosaur | <input type="text"/> | 33. lobster | <input type="text"/> | 53. swimmer | <input type="text"/> |
| 14. diaper | <input type="text"/> | 34. manicure | <input type="text"/> | 54. teacher | <input type="text"/> |
| 15. doctor | <input type="text"/> | 35. matador | <input type="text"/> | 55. tiger | <input type="text"/> |
| 16. dollar | <input type="text"/> | 36. mature | <input type="text"/> | 56. tractor | <input type="text"/> |
| 17. downpour | <input type="text"/> | 37. mother | <input type="text"/> | 57. umpire | <input type="text"/> |
| 18. éclair | <input type="text"/> | 38. newspaper | <input type="text"/> | 58. vampire | <input type="text"/> |
| 19. elsewhere | <input type="text"/> | 39. painter | <input type="text"/> | 59. wheelchair | <input type="text"/> |
| 20. farmer | <input type="text"/> | 40. panther | <input type="text"/> | 60. zipper | <input type="text"/> |

© 1993, Super Dupere School Co.

Name _____ Date _____

Helper's Signature _____

Speech-Language Pathologist _____

Skill: Final R in words, two or more syllables

Final R Phrases



Instructions

1. eagerer beaverer
2. herer new car
3. clean floor
4. close the door
5. a big dinosaur
6. pairer of gloves
7. motherer and father
8. play guitar
9. sore muscles
10. stirer the soup
11. sweet and sour
12. a soft chair
13. hammerer and nail
14. my brother
15. black bear
16. hereer it is
17. herer long hair
18. jarer of olives
19. score a hit
20. fairer and square

21. before or after
22. change a tire
23. pour juice
24. lead a cheer
25. deer in woods
26. care for him
27. here you are
28. moon and star
29. a good year
30. go in there
31. black spider
32. take a shower
33. pick a flower
34. dollar value
35. admire you
36. a ripe pear
37. fear not
38. sure of it
39. new cashier
40. diaper change

© 1993, Super Dupere School Co.

Name _____

Date _____

Helper's Signature _____

Skill: Final R in phrases

Speech-Language Pathologist

Final R Sentences



Instructions _____

- | | | | |
|------------------------------------|--|------------------------------------|--|
| 1. I admire my teacher. | <input type="checkbox"/> <input type="checkbox"/> <input type="checkbox"/> <input type="checkbox"/> <input type="checkbox"/> | 21. My father is a juggler. | <input type="checkbox"/> <input type="checkbox"/> <input type="checkbox"/> <input type="checkbox"/> <input type="checkbox"/> |
| 2. An alligator has sharp teeth. | <input type="checkbox"/> <input type="checkbox"/> <input type="checkbox"/> <input type="checkbox"/> <input type="checkbox"/> | 22. I found a feather. | <input type="checkbox"/> <input type="checkbox"/> <input type="checkbox"/> <input type="checkbox"/> <input type="checkbox"/> |
| 3. The bear is in the woods. | <input type="checkbox"/> <input type="checkbox"/> <input type="checkbox"/> <input type="checkbox"/> <input type="checkbox"/> | 23. This flower smells sweet. | <input type="checkbox"/> <input type="checkbox"/> <input type="checkbox"/> <input type="checkbox"/> <input type="checkbox"/> |
| 4. Will the bottle float ashore? | <input type="checkbox"/> <input type="checkbox"/> <input type="checkbox"/> <input type="checkbox"/> <input type="checkbox"/> | 24. She cut her hair today. | <input type="checkbox"/> <input type="checkbox"/> <input type="checkbox"/> <input type="checkbox"/> <input type="checkbox"/> |
| 5. Mr. Owen is a baker. | <input type="checkbox"/> <input type="checkbox"/> <input type="checkbox"/> <input type="checkbox"/> <input type="checkbox"/> | 25. The hammer is here. | <input type="checkbox"/> <input type="checkbox"/> <input type="checkbox"/> <input type="checkbox"/> <input type="checkbox"/> |
| 6. The beaver built a dam. | <input type="checkbox"/> <input type="checkbox"/> <input type="checkbox"/> <input type="checkbox"/> <input type="checkbox"/> | 26. When did you see her? | <input type="checkbox"/> <input type="checkbox"/> <input type="checkbox"/> <input type="checkbox"/> <input type="checkbox"/> |
| 7. Where is your brother? | <input type="checkbox"/> <input type="checkbox"/> <input type="checkbox"/> <input type="checkbox"/> <input type="checkbox"/> | 27. The show lasts one hour. | <input type="checkbox"/> <input type="checkbox"/> <input type="checkbox"/> <input type="checkbox"/> <input type="checkbox"/> |
| 8. Let's make a campfire. | <input type="checkbox"/> <input type="checkbox"/> <input type="checkbox"/> <input type="checkbox"/> <input type="checkbox"/> | 28. Tim keeps pennies in a jar. | <input type="checkbox"/> <input type="checkbox"/> <input type="checkbox"/> <input type="checkbox"/> <input type="checkbox"/> |
| 9. Her car is in the driveway. | <input type="checkbox"/> <input type="checkbox"/> <input type="checkbox"/> <input type="checkbox"/> <input type="checkbox"/> | 29. May I borrow your ladder? | <input type="checkbox"/> <input type="checkbox"/> <input type="checkbox"/> <input type="checkbox"/> <input type="checkbox"/> |
| 10. I care about you. | <input type="checkbox"/> <input type="checkbox"/> <input type="checkbox"/> <input type="checkbox"/> <input type="checkbox"/> | 30. She wrote a letter to Sue. | <input type="checkbox"/> <input type="checkbox"/> <input type="checkbox"/> <input type="checkbox"/> <input type="checkbox"/> |
| 11. Please sit in this chair. | <input type="checkbox"/> <input type="checkbox"/> <input type="checkbox"/> <input type="checkbox"/> <input type="checkbox"/> | 31. The lobster is in the ocean. | <input type="checkbox"/> <input type="checkbox"/> <input type="checkbox"/> <input type="checkbox"/> <input type="checkbox"/> |
| 12. Did she do her chore? | <input type="checkbox"/> <input type="checkbox"/> <input type="checkbox"/> <input type="checkbox"/> <input type="checkbox"/> | 32. You are a mature person. | <input type="checkbox"/> <input type="checkbox"/> <input type="checkbox"/> <input type="checkbox"/> <input type="checkbox"/> |
| 13. His dog has a collar. | <input type="checkbox"/> <input type="checkbox"/> <input type="checkbox"/> <input type="checkbox"/> <input type="checkbox"/> | 33. My mother is fantastic. | <input type="checkbox"/> <input type="checkbox"/> <input type="checkbox"/> <input type="checkbox"/> <input type="checkbox"/> |
| 14. Which dinosaur is the biggest? | <input type="checkbox"/> <input type="checkbox"/> <input type="checkbox"/> <input type="checkbox"/> <input type="checkbox"/> | 34. He will deliver the newspaper. | <input type="checkbox"/> <input type="checkbox"/> <input type="checkbox"/> <input type="checkbox"/> <input type="checkbox"/> |
| 15. Our baby wears a diaper. | <input type="checkbox"/> <input type="checkbox"/> <input type="checkbox"/> <input type="checkbox"/> <input type="checkbox"/> | 35. The kitty began to purr. | <input type="checkbox"/> <input type="checkbox"/> <input type="checkbox"/> <input type="checkbox"/> <input type="checkbox"/> |
| 16. She is a famous doctor. | <input type="checkbox"/> <input type="checkbox"/> <input type="checkbox"/> <input type="checkbox"/> <input type="checkbox"/> | 36. Her dad uses a razor to shave. | <input type="checkbox"/> <input type="checkbox"/> <input type="checkbox"/> <input type="checkbox"/> <input type="checkbox"/> |
| 17. We left the door open. | <input type="checkbox"/> <input type="checkbox"/> <input type="checkbox"/> <input type="checkbox"/> <input type="checkbox"/> | 37. What's the score? | <input type="checkbox"/> <input type="checkbox"/> <input type="checkbox"/> <input type="checkbox"/> <input type="checkbox"/> |
| 18. The fair is coming to town. | <input type="checkbox"/> <input type="checkbox"/> <input type="checkbox"/> <input type="checkbox"/> <input type="checkbox"/> | 38. Donna takes a shower at night. | <input type="checkbox"/> <input type="checkbox"/> <input type="checkbox"/> <input type="checkbox"/> <input type="checkbox"/> |
| 19. Hank lit the fire. | <input type="checkbox"/> <input type="checkbox"/> <input type="checkbox"/> <input type="checkbox"/> <input type="checkbox"/> | 39. I will wear a sweater. | <input type="checkbox"/> <input type="checkbox"/> <input type="checkbox"/> <input type="checkbox"/> <input type="checkbox"/> |
| 20. The spoon fell to the floor. | <input type="checkbox"/> <input type="checkbox"/> <input type="checkbox"/> <input type="checkbox"/> <input type="checkbox"/> | 40. Your jacket has a zipper. | <input type="checkbox"/> <input type="checkbox"/> <input type="checkbox"/> <input type="checkbox"/> <input type="checkbox"/> |

© 1993, Super Dupers School Co.

Name

Date

Helper's Signature

Skill: Final R in sentences